

6 5 4 3 2 1

D

D

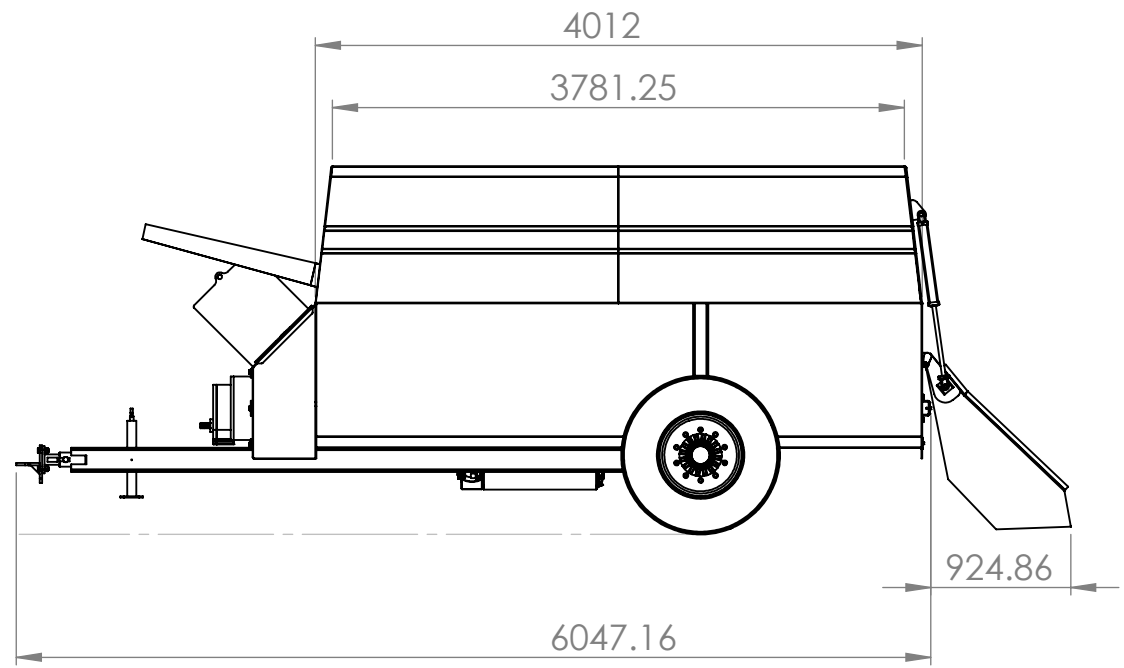
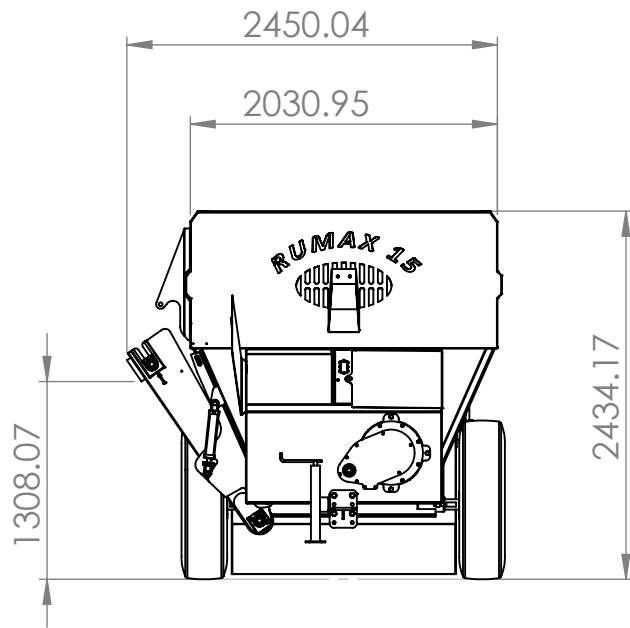

C

C

B

B

A

A

6 5 4 3 2 1

DO NOT SCALE DRAWING		REVISION 1	
RUMAX			
TITLE:		RUMAX 15	
DWG NO.		1	
		A4	
SCALE:1:100		SHEET 1 OF 1	